

Digital Engineer

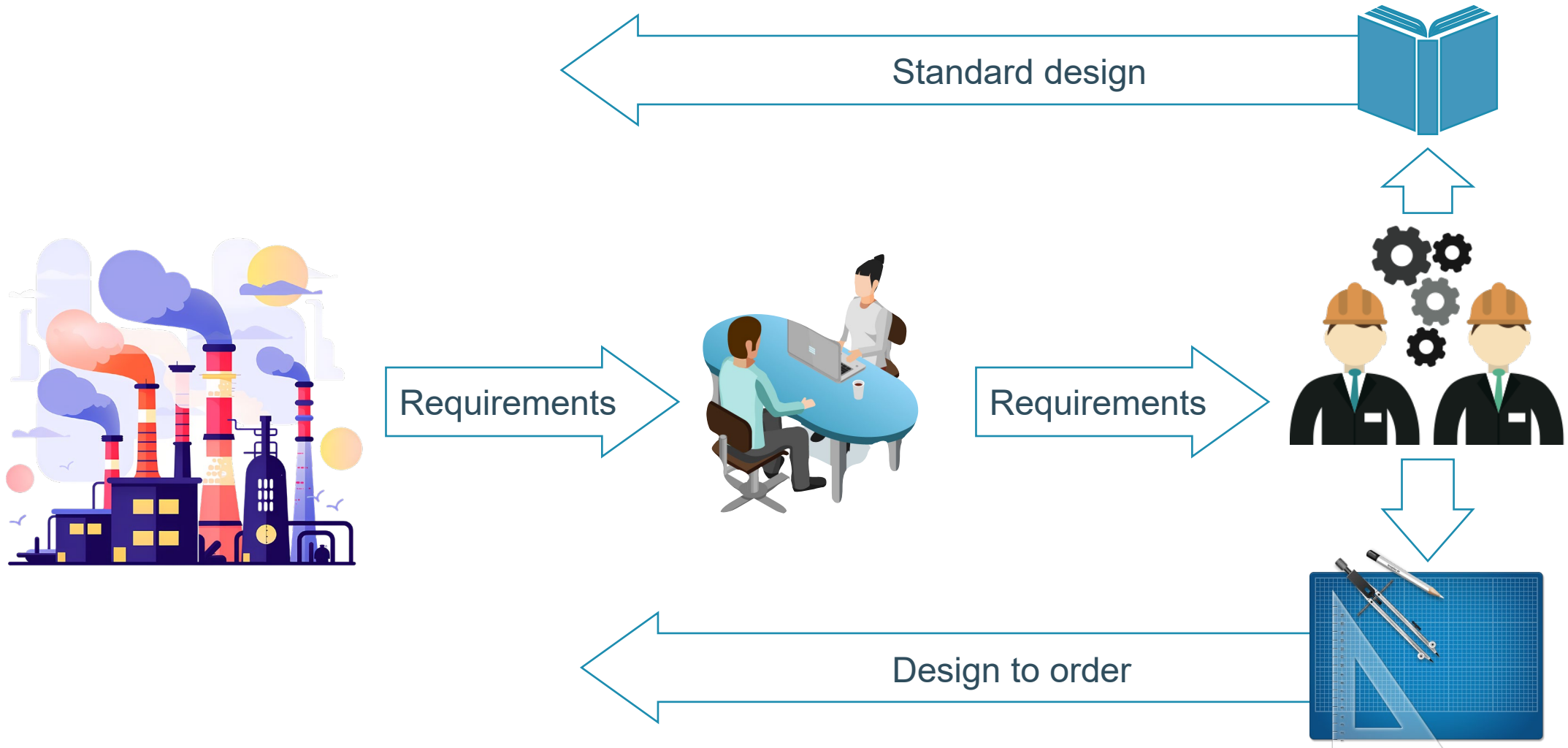

Process (before)



Goals

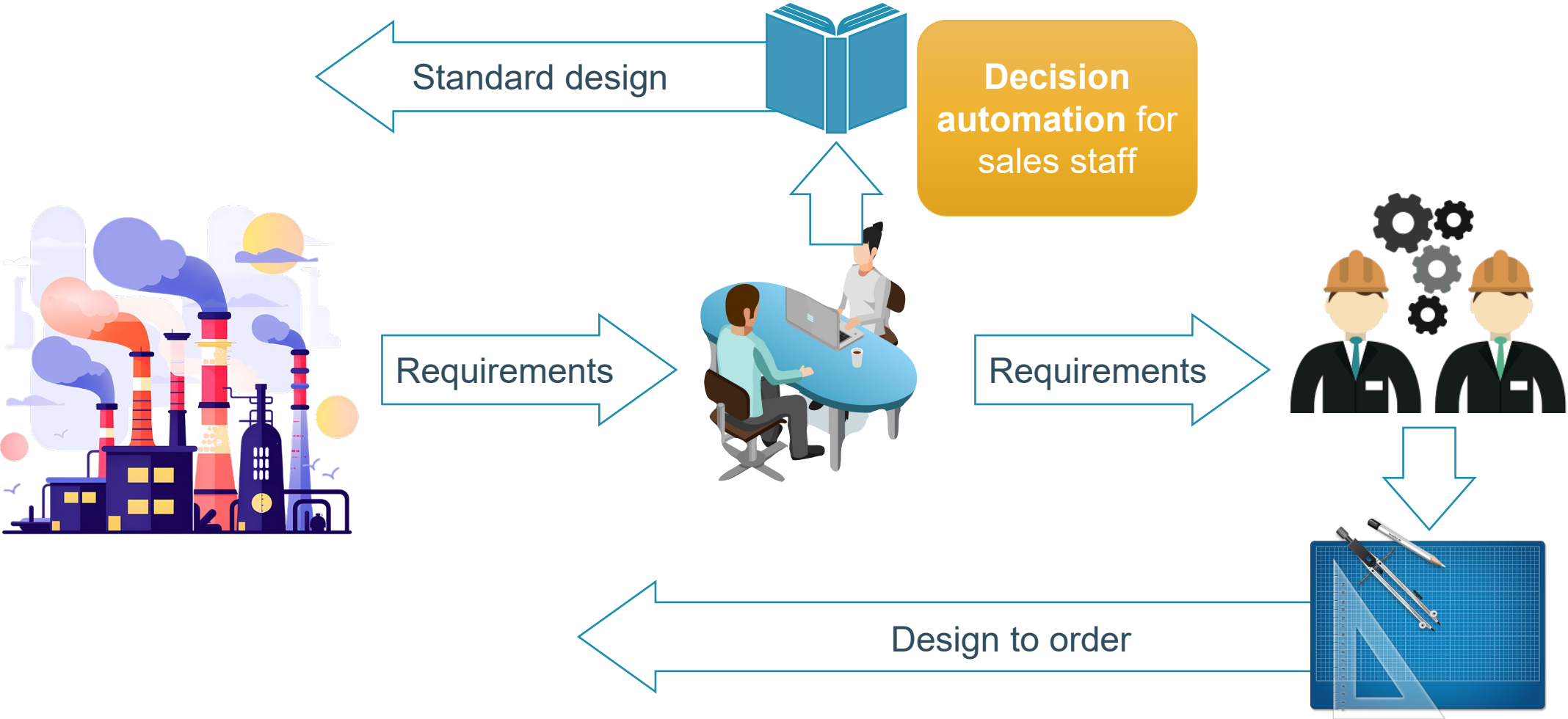

Goals

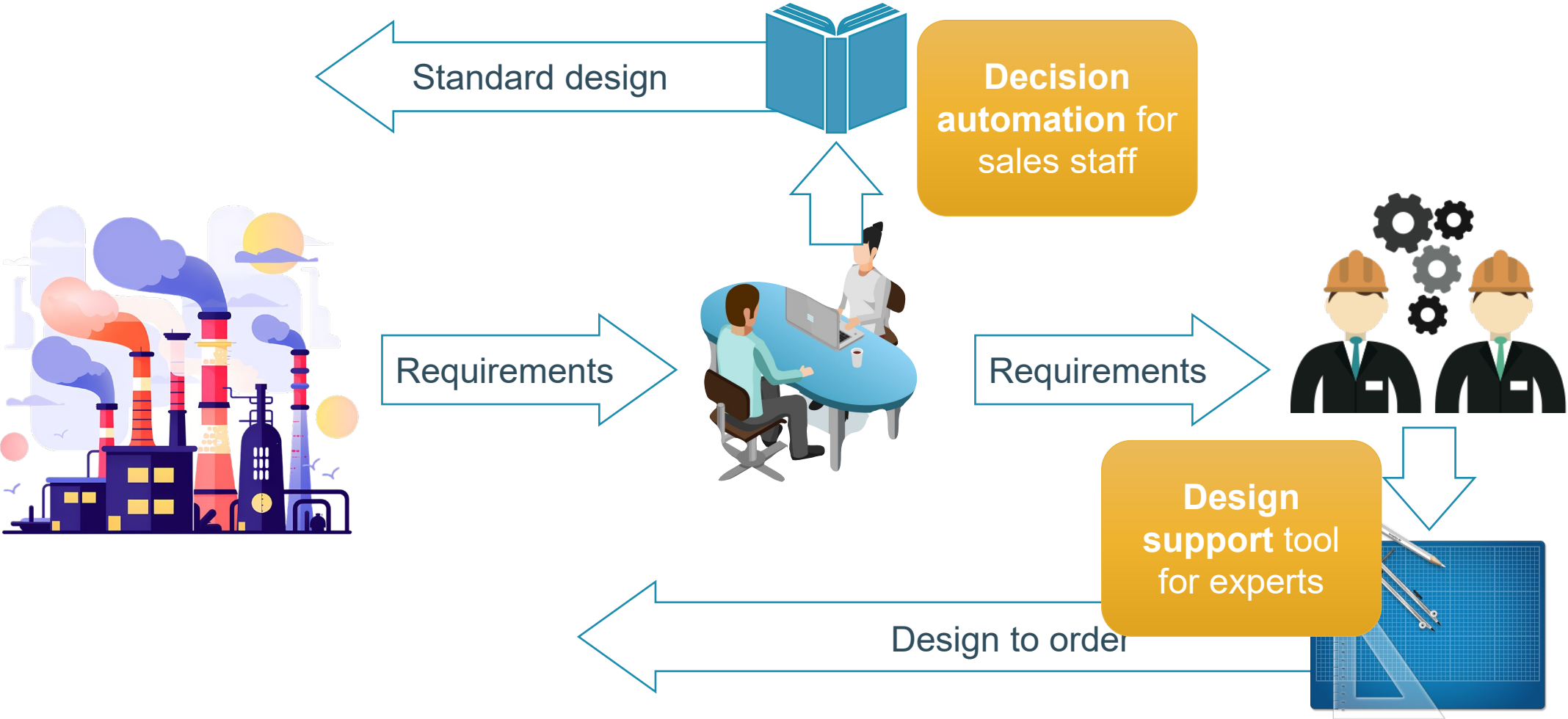

Resources

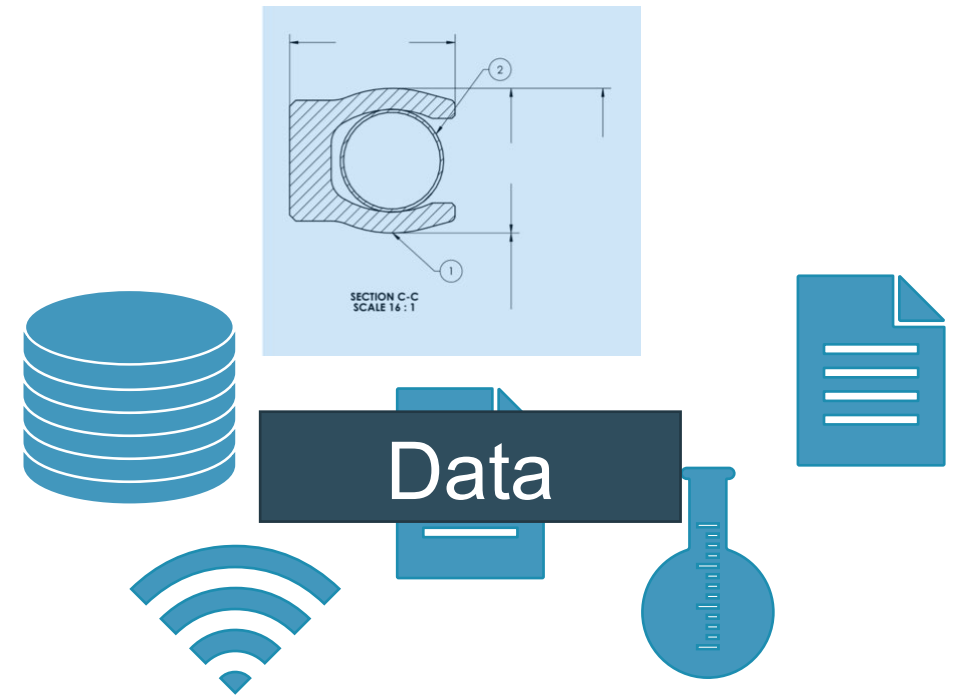

Resources



Knowledge

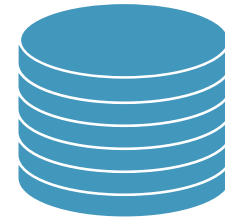
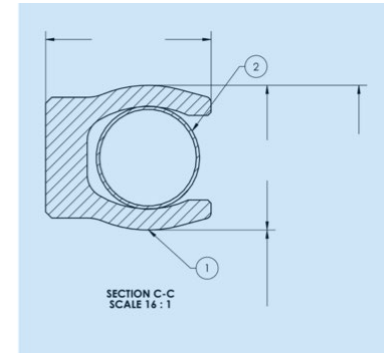

Data



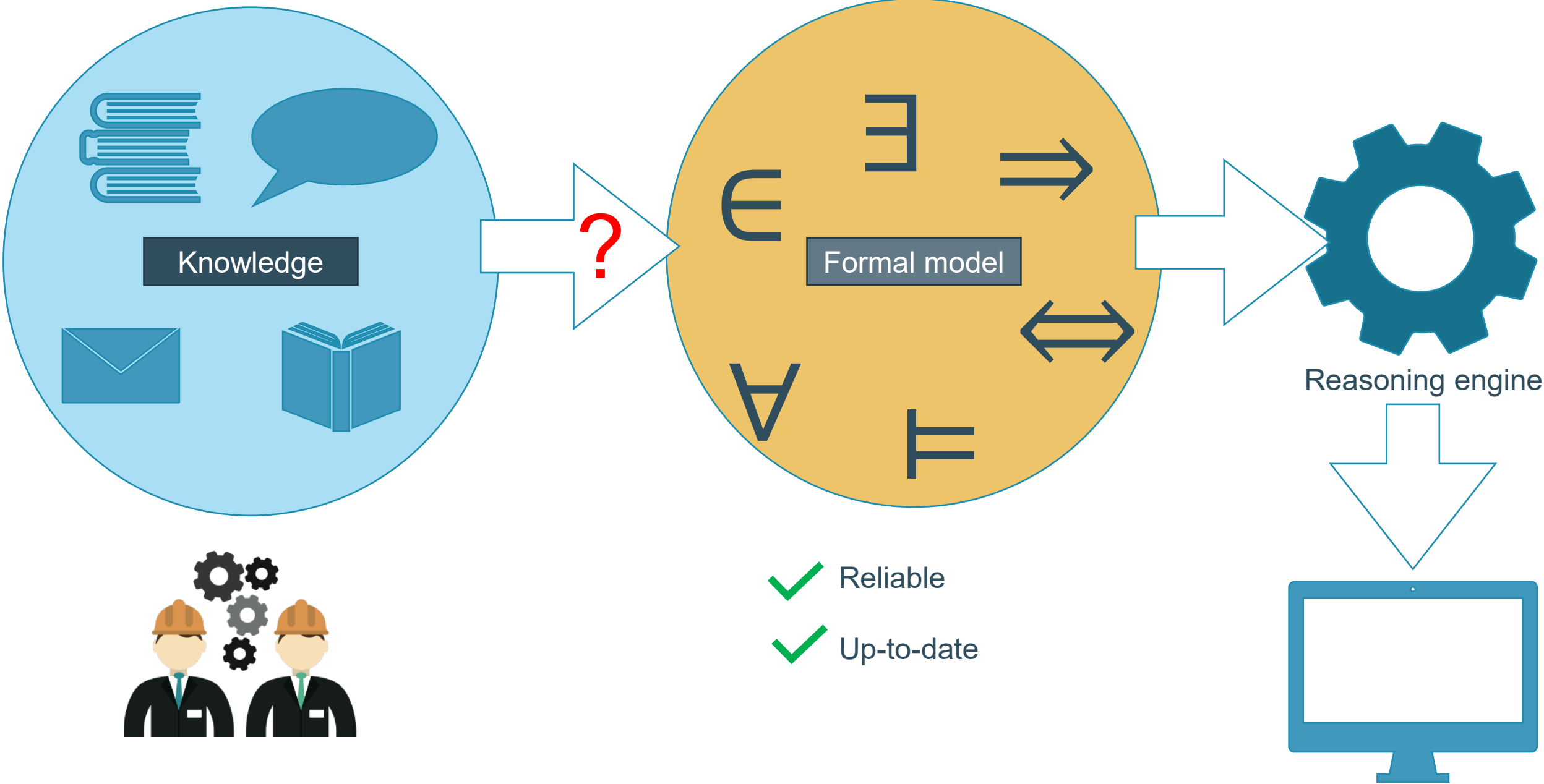

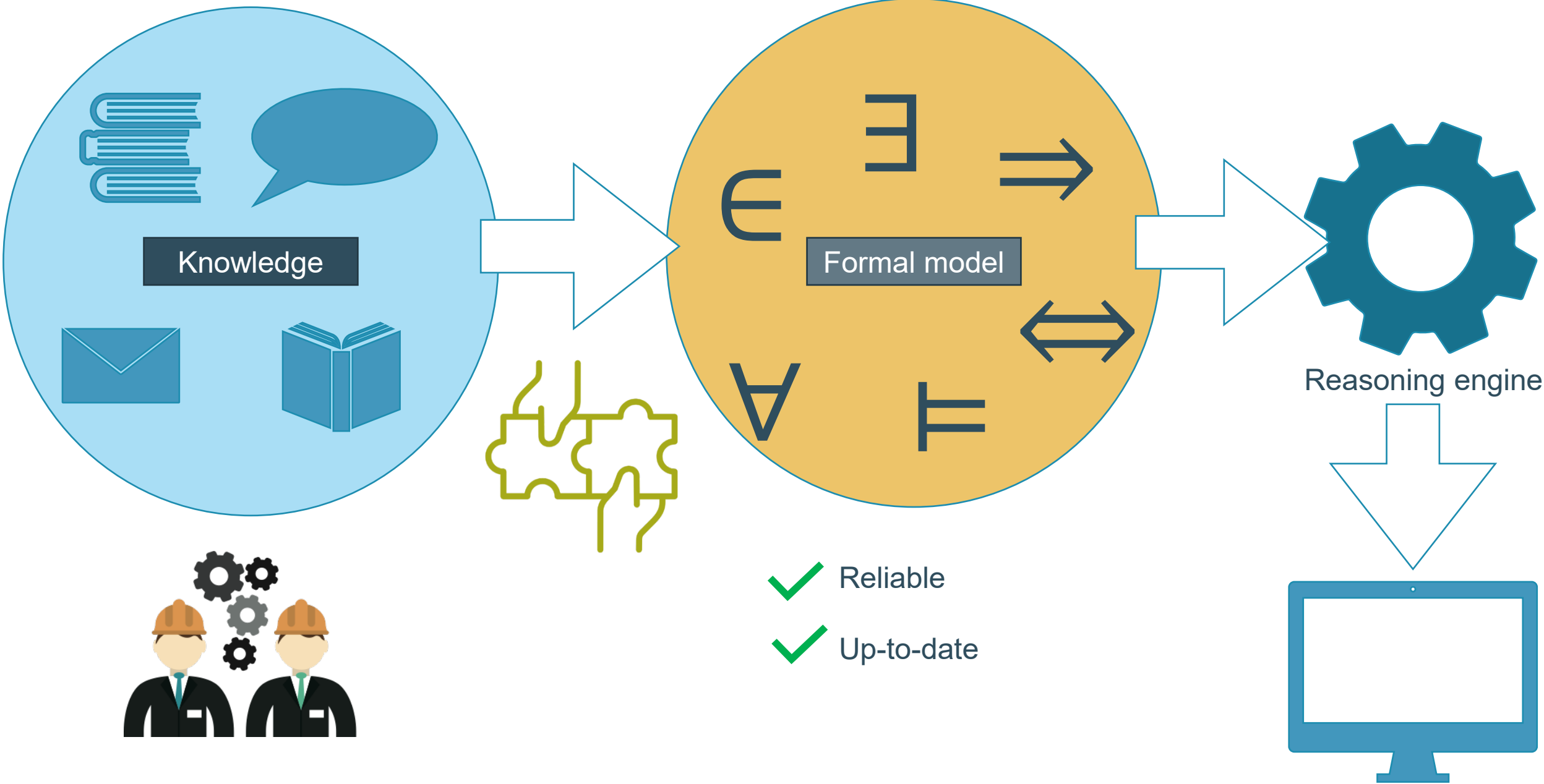

- ✓ Reliable
- ✓ Up-to-date

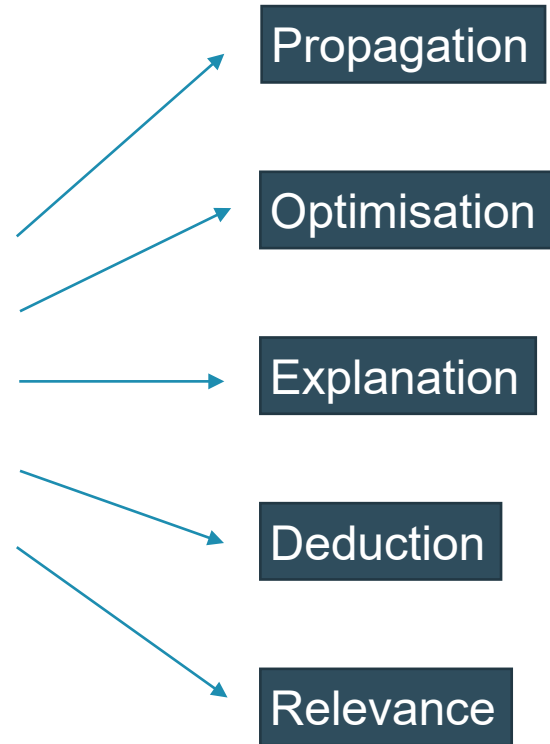
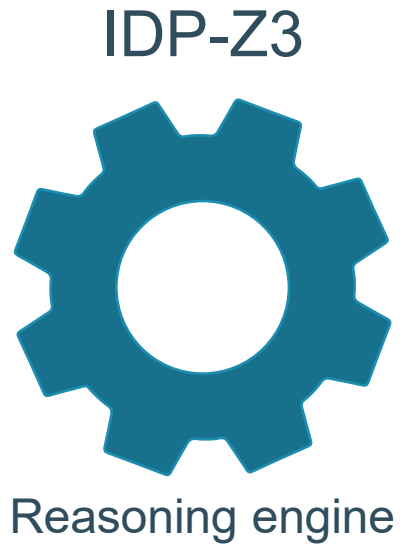

Interactive Consultant

The interface displays several panels for design parameters:

- Position:**
 - Pressure_Accumulating:
 - Bi_Directional:
 - Standard:
- Pressure:** Slider set to 167, with a refresh button.
- Back_Pressure:**
- Design_Type:**
 - Open:

Above choice is implied by the following choice(s):

 - Back_Pressure: true
 - Pressure: 167

With the following constraints:

 - Closed designs do not have a spacer
 - Spacer is needed if BP > 150
- Spring_Thickness:**
 - Normal:
 - Thick:
- Material:**
 - Body:
 - M1:
 - M2:
 - M3:
 - M5:

[Pierre Carbonelle, Marc Denecker, et al.]

Resources

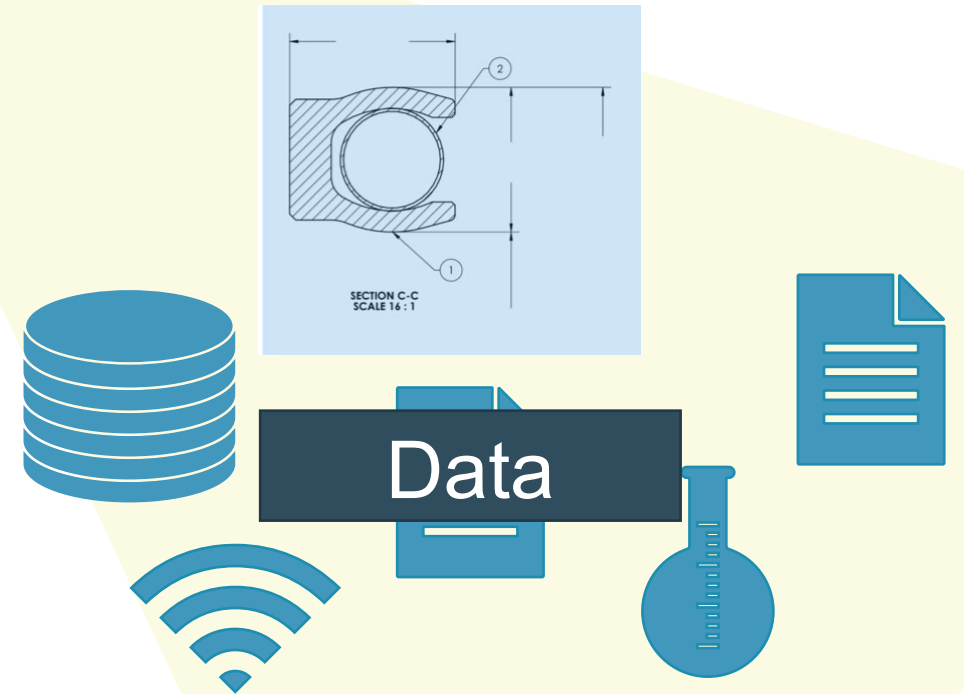

Analysis of unlabeled database

CAD drawing → ANN embedding
Similarity between designs

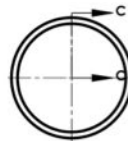
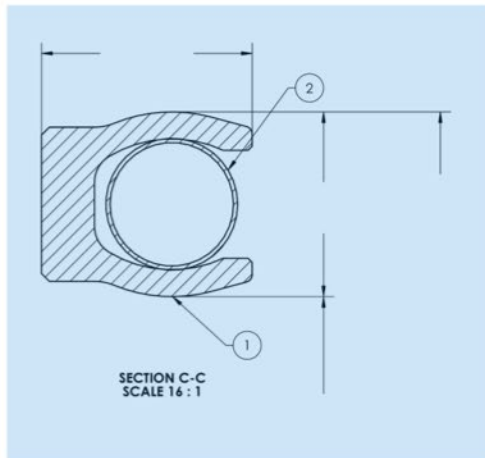

Table → ILP feature extraction
Link to knowledge-base concepts

REV	DESCRIPTION	BY	DATE	APPR
2	1			
1	1			

ITEM	QTY	Partnumber	Description	Material	Material Spec.
2	1		Coiled spring with HT	COBALT NICKEL ALLOY	FSS0010
1	1		Jacket	FLUOROPOLY A02	HPSA102

DRAWN		DATE		PREPARED FOR	
Drive Works	V01	19 Jul 2016			

SCALE	DWG NO.	REV
A3		NC

SCALE	SHEET
SCALE: 2:3	SHEET 1 OF 1

part(A,B) :-
neutral_element(A), above_below(B,C), header(C).

part(A,B) :-
my_succ(C,A), above_below(B,D), part(C,D).

header(A) :-
above_below(A,B),
cell_contains(B, list).

[Dries Van Daele, Wannes Meert]

Integrate

Position

- Pressure_Accumulating
- BI_Directional
- Standard

Back_Pressure

Design_Type

Open

Above choice is implied by the following choice(s):

Back_Pressure true

Pressure 167

With the following constraints:

- Closed designs do not have a spacer
- Spacer is needed if BP > 150

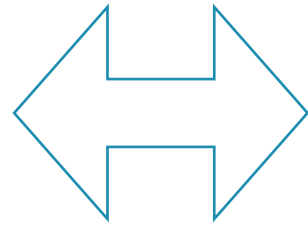

230307641	230320565-02NK	480305822-LF
<input checked="" type="checkbox"/> <input checked="" type="checkbox"/> <input checked="" type="checkbox"/>	<input checked="" type="checkbox"/> <input checked="" type="checkbox"/> <input checked="" type="checkbox"/>	<input checked="" type="checkbox"/> <input checked="" type="checkbox"/> <input checked="" type="checkbox"/>
<p>Extended Heel <input checked="" type="checkbox"/> true</p> <p>Insert <input checked="" type="checkbox"/> false</p> <p>JacketDesign <input checked="" type="checkbox"/> Design 230</p>	<p>BackupDesign <input checked="" type="checkbox"/> ? ABU</p> <p>Extended Heel <input checked="" type="checkbox"/> false</p> <p>Insert <input checked="" type="checkbox"/> false</p> <p>JacketDesign <input checked="" type="checkbox"/> Design 230</p> <p>Material <input checked="" type="checkbox"/></p>	<p>BackupDesign <input type="text"/></p> <p>ExtendedHeel <input type="text"/></p> <p>Insert <input type="text"/></p> <p>JacketDesign <input type="text"/></p> <p>Material: Insert <input type="text"/></p> <p>Material: Jacket <input type="text"/></p> <p>Material: Spacer <input type="text"/></p>

Operator advice (ongoing)

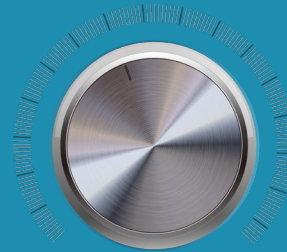
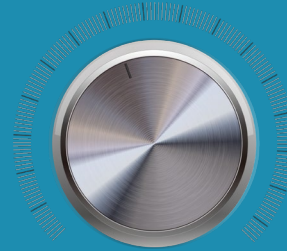
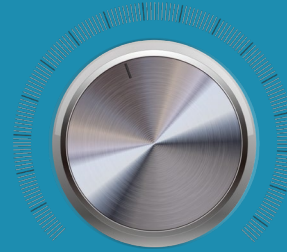

"Toy" use case: PID controller in oven

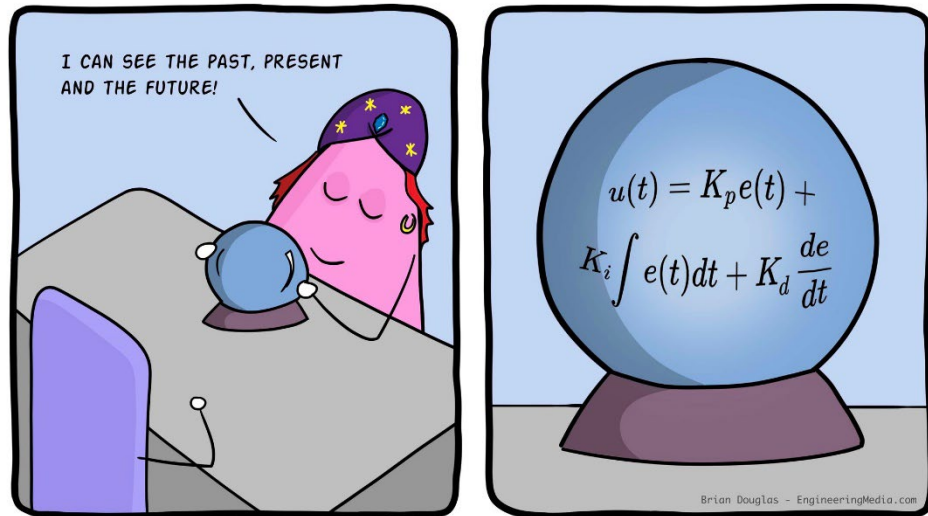







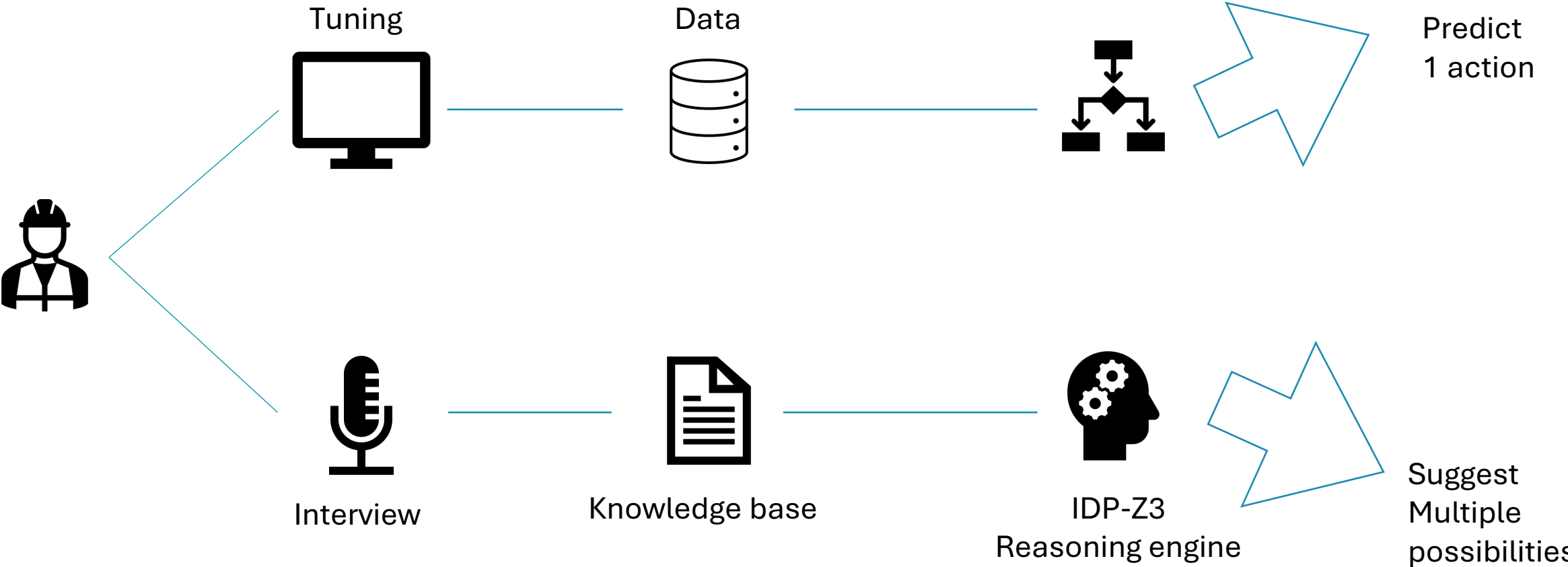











<https://engineeringmedia.com/comics/22>





























Experiments













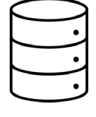









 = 	 = 	 = 	436	

  	  	  	436	
			288	

 = 	 = 	 = 	436	
			288	
			106	Different priority

 = 	 = 	 = 	436	
			288	
			106	Different priority
			31	Operator mistake?

 = 	 = 	 = 	436	
			288	
			106	Different priority
			31	Operator mistake?
			4	KB can correct Machine Learning
			6	Out of scope of knowledge Base

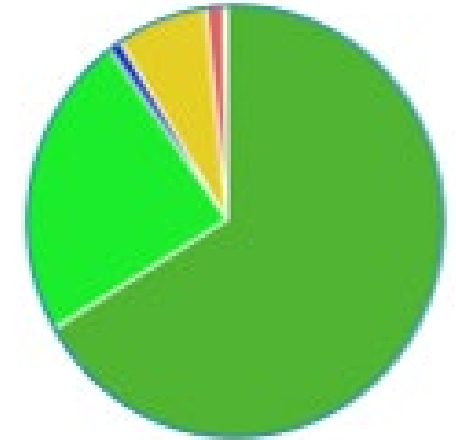

Integration using knowledge graphs

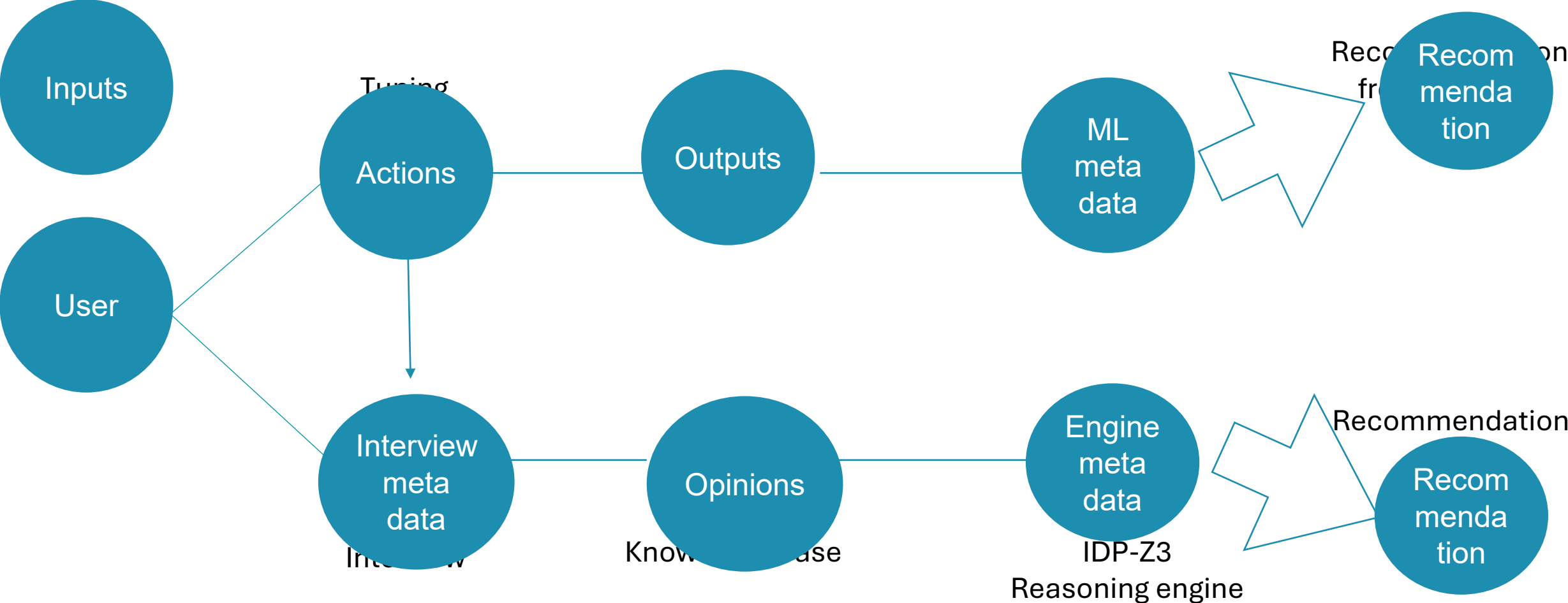

Data Collection and Knowledge Elicitation

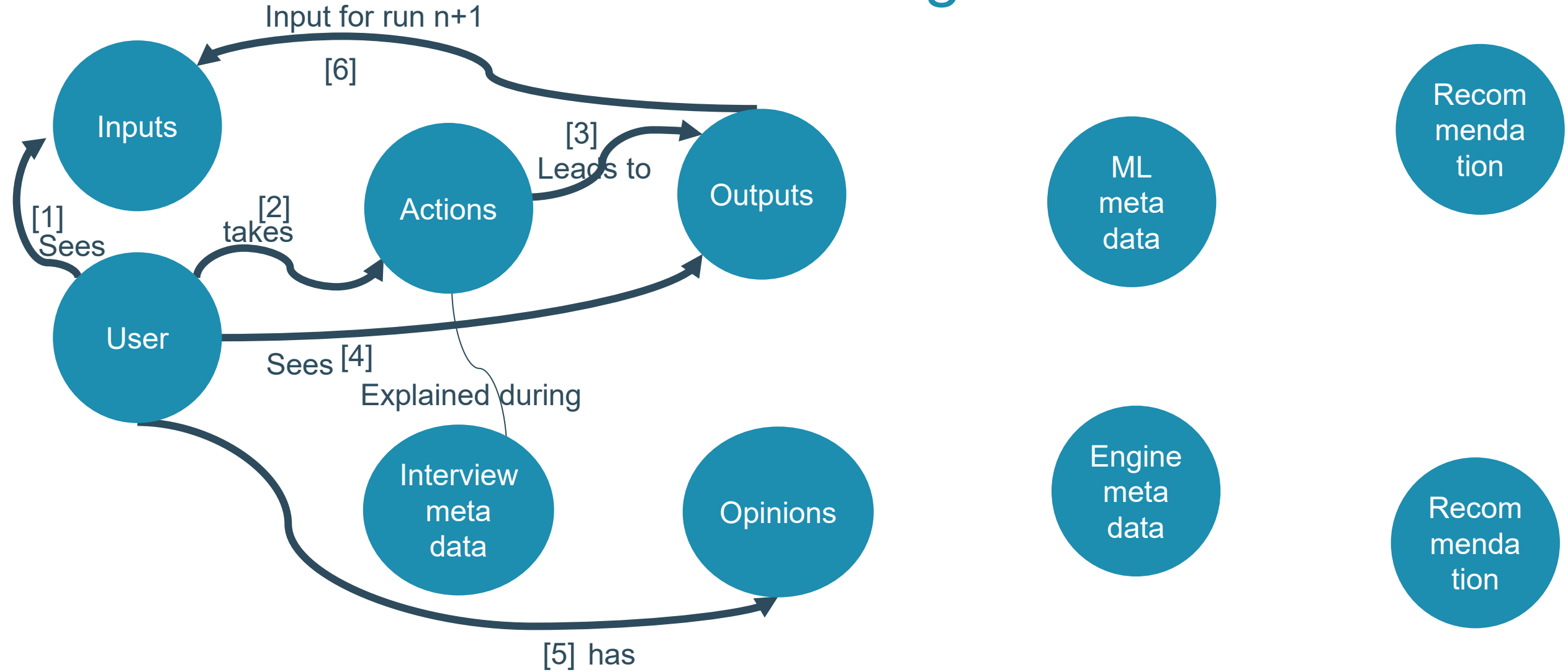

Online recommendations

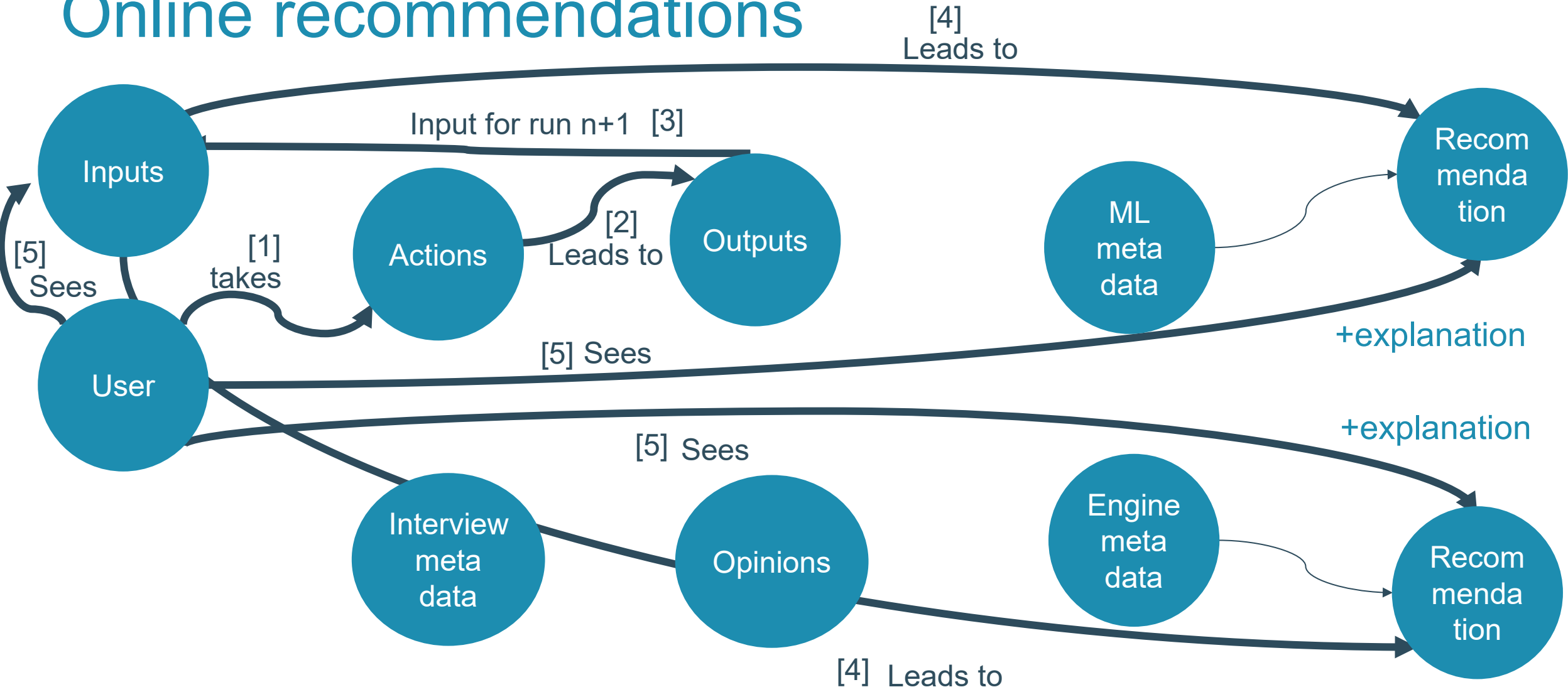

Leveraging the Knowledge Graph Structure

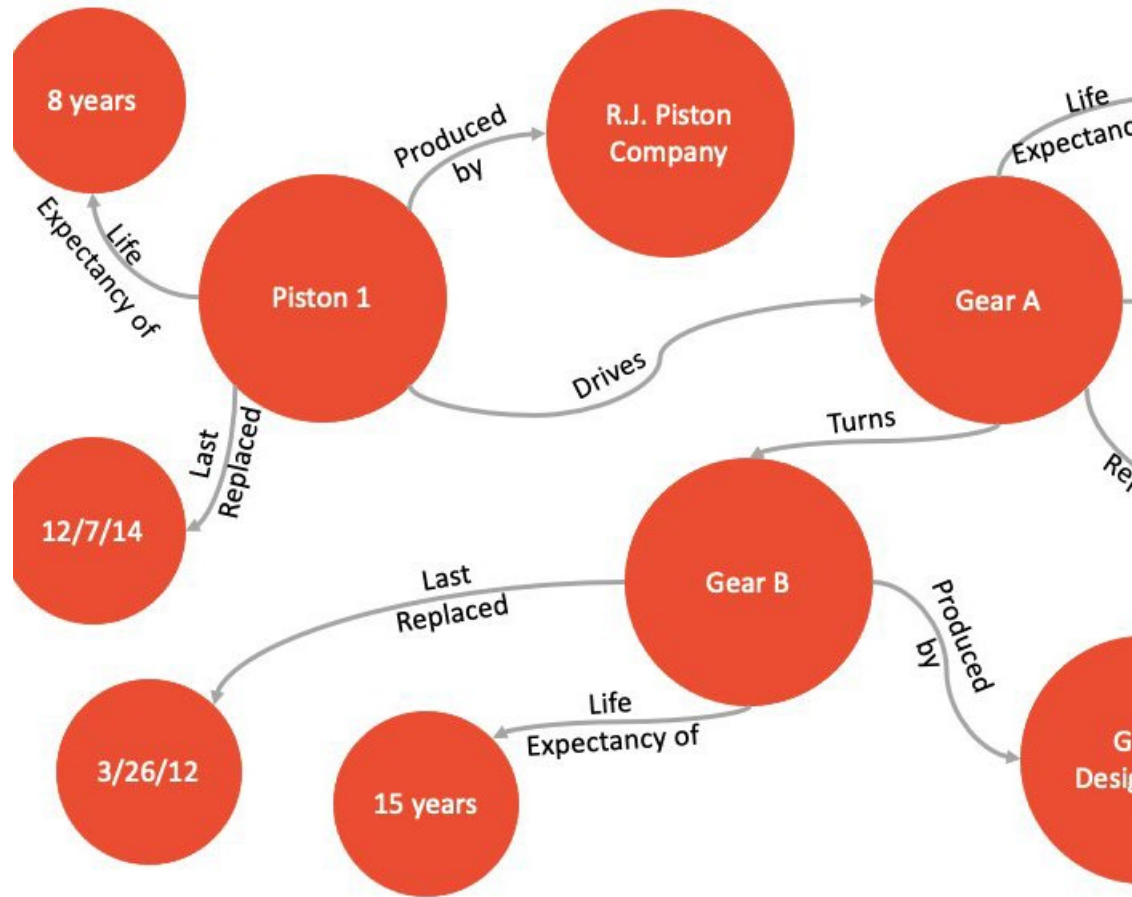

Flexible data model

Semantic understanding

Cross-domain integration

Scalable

What we learn from the cases



Safeguarding
knowledge

Lowering learning
curve

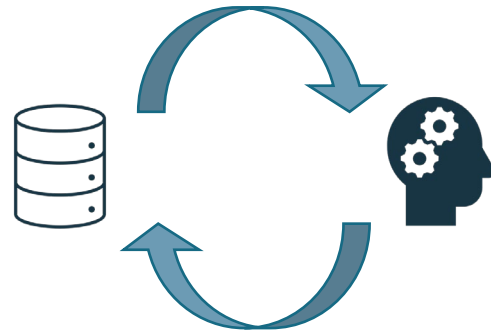

ML to predict action
KB to explain why

Complementarity

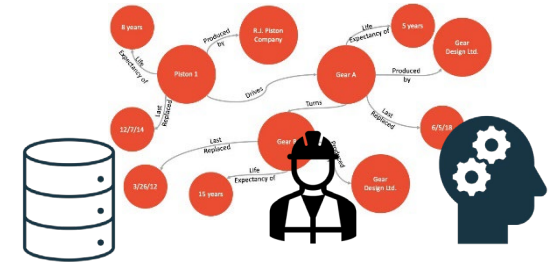

Knowledge Graphs
to integrate data and
knowledge base
approaches

Interactive Consultant

Position

- ✓ x Pressure_Accumulating
- ✓ x BI_Directional
- ✓ x Standard

Back_Pressure ↻

Design_Type

- ? Open

Above choice is implied by the following choice(s):

- Back_Pressure ↻ true
- Pressure ↻ 167

With the following constraints:

- x Closed designs do not have a spacer
- x Spacer is needed if BP > 150

IDP-Z3 Reasoning Engine

FORMAL KB

**DMN
cDMN**

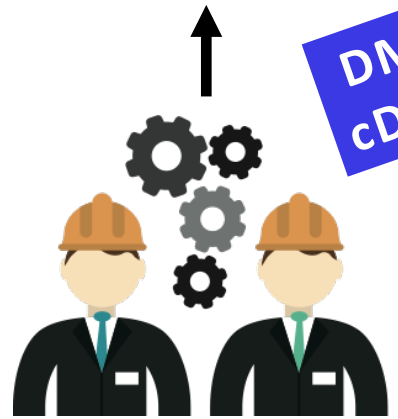

Knowledge

Neural Networks

Inductive Logic Programming

MACHINE LEARNING MODEL

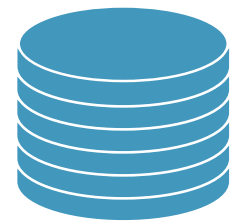

Data



Modeling Simulation Data with MLSO

MLSO is an ontology for representing machine learning datasets, pipelines, experiment configurations and results and scientific works.

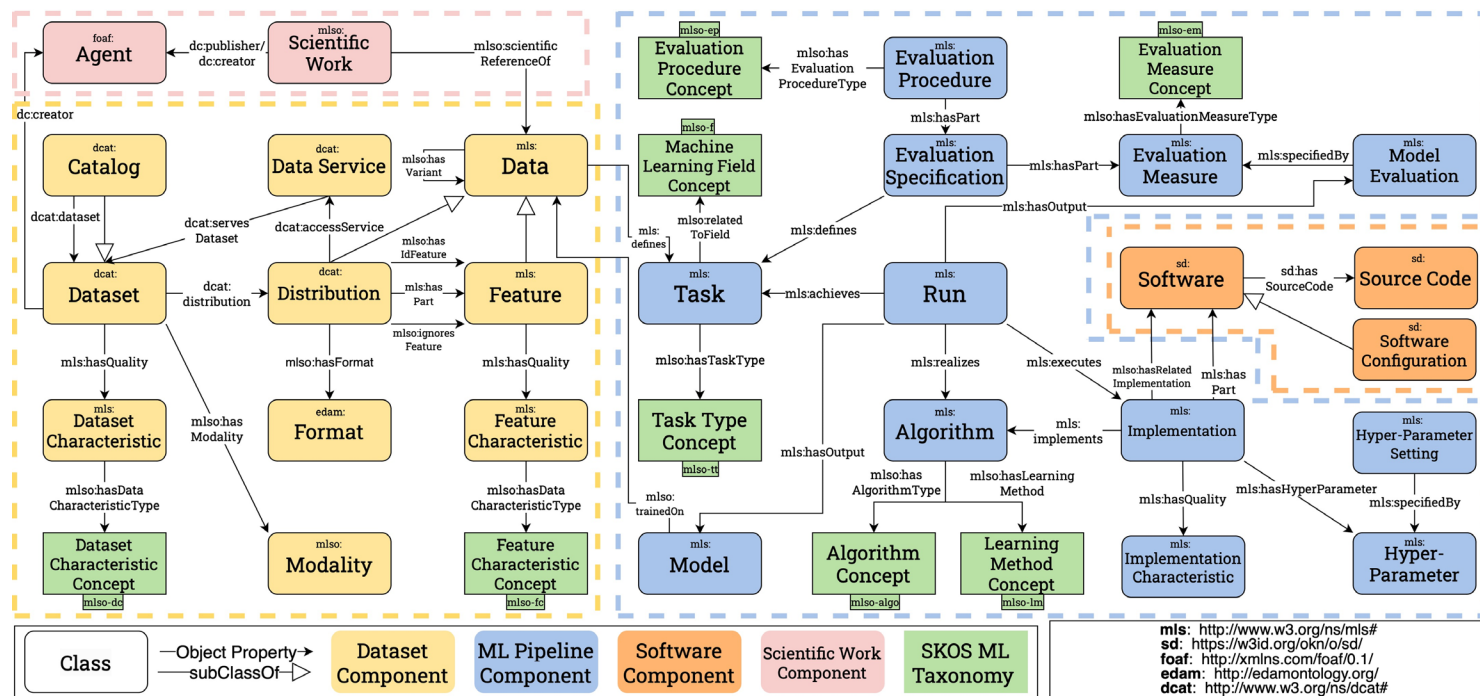

- Schema based on the publicly available experiment data and past standards
- 4 groups of components:
 - **Dataset Components**
 - **Machine Learning Pipeline Components**
 - **Software Components**
 - **Scientific Work Components**

Online stage

